

UFO 700/880

Aqua One®



Instruction Manual

Important Safeguards

This appliance is not intended for use by children or infirm persons without supervision. Young children should be supervised to ensure that they do not play with the appliance.

Warning: To guard against injury, basic safety precautions should be observed, including the following:

1. Read and follow all safety instructions before using this appliance.

2. Danger: To avoid possible electric shocks, special care should be taken since water is employed in the use of aquarium equipment. For each of the following situations do not attempt repairs yourself. Return the appliance to an authorised service facility for service or discard the appliance.

a) If the light falls into water, do not reach for it, unplug it and then retrieve it. If the electrical components of the appliance get wet, unplug the appliance immediately (non immersible equipment only).

b) If the aquarium shows any sign of abnormal water leakage, immediately unplug it from the power source.

c) Carefully examine the aquarium after installation. It should not be plugged in when there is water on parts which are not intended to be wet.

d) Do not operate any aquarium if it has a damaged cord or plug, or if it is malfunctioning, or dropped or damaged in any manner.

A "drip loop" (See the diagram) should be arranged by the user for each cord connecting an aquarium component to a receptacle. The drip loop is the part of the cord below the level of the receptacle or the connector if an extension cord is used. It is used to prevent water traveling along the cord and coming in contact with the receptacle.

If the plug or receptacle does get wet, do not unplug the appliance. Disconnect the fuse or circuit breaker that supplies the power to the appliance, then unplug and examine for presence of water in the receptacle.

3. Close supervision is necessary when the appliance is used by or near children.

4. Always unplug the aquarium from the electrical outlet, when not in use, before putting on or taking off parts, before any type of maintenance,

or cleaning. Never yank the cord to pull it from the outlet. Grasp the plug and unplug to disconnect.

5. Do not use the aquarium for reasons other than the intended use. The use of attachments that are not recommended or sold by the aquarium manufacturer may cause the product to be unsafe. This is not recommended.

6. Do not install or store the aquarium where it will be exposed to weather or temperatures below freezing.

7. Make sure any component mounted on a tank is securely installed before operating it.

8. Read and observe all the important notices on the aquarium.

9. Ensure input voltage is the same voltage as your local power supply.

10. If an extension cord is necessary, a cord with a proper rating should be used. Care should be taken to arrange the cord so that it will not be tripped or pulled.

11. A **G.F.C.I** (Ground fault circuit interrupter) & surge protector is recommended for all electrical appliances.

12. Ensure your hand is dry when turning the power switch on/off and when inserting/removing the power cord from the receptacle.

13. If you are in any doubt about the electrical installation or safety of this product you must consult a qualified electrician.

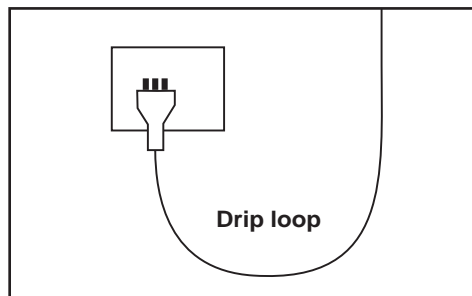

For Guarantee Conditions, please refer to the Guarantee form that is enclosed with this product.

Before First Use / Preparation

Read and follow all the instructions, even if you feel you are familiar with the product and find a place to keep the instructions handy for future reference. Your attention is drawn particularly to the sections concerning **“IMPORTANT SAFEGUARDS”** and the **“GUARANTEE CONDITIONS”**. Please ensure you retain your original purchase receipt in the event that guarantee service is required.

Carefully unpack the aquarium making sure you keep all the packing material until all the parts of the product have been found and the product has been assembled.

This product is shipped to you in a factory sealed carton. Should the product malfunction in any way or if the unit is damaged and requires replacement, contact the retailer where the product was purchased for inspection.

Know Your Tank

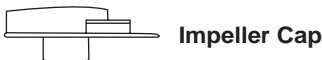
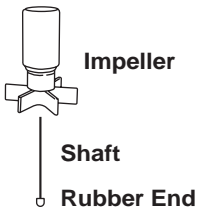
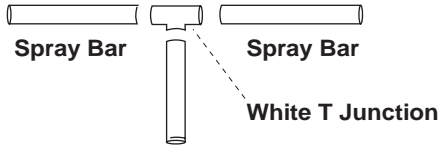

Replacement Parts & Filter Media

Use Aqua One Genuine Spare Parts Only. See your local Aqua One Dealer and look for the number listed below for the spare part you require. Alternatively you will find these numbers on the silver label located on the product.

UFO 700 Black Sponge	58S
UFO 700 White Wool Pad	58W
UFO 700 Impeller	41
UFO 880 Black Sponge	50S
UFO 880 White Wool Pad	50W
UFO 880 Impeller	50I

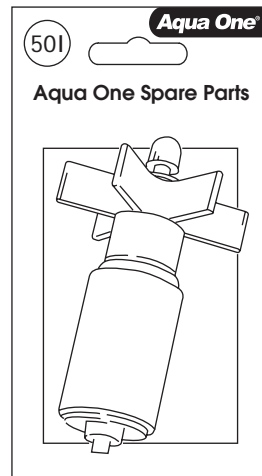

Set Up Instructions

1. Remove the **Filter Unit** and **Light Unit** from the Aquarium Body.

2. Take the **Lid** on the **Filter Unit** off.

3. Remove the **Spray Bar**, **Power Head** and all filter media.

4. Turn the **Filter Unit** over and slide the **Power Head** into the bottom of it. Fig 1 Note: This may be a tight fit.

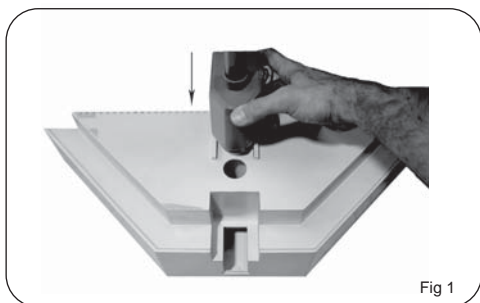

5. Take the **Filter Unit** and all filter media to the sink. Ensure there is no detergent residue in or around the sink.

6. Open the **Ceramic Noodles** and **Carbon**. (See **Tips**)

7. Empty the **Ceramic Noodles** into one **Filter Tray**. Place the **Carbon** bag into the other. Fig 2

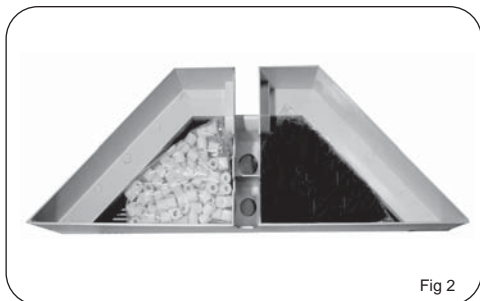

8. Run tap water through them to remove any dust. **DO NOT WASH IN SOAP OR DETERGENT.**

9. Rinse the **Wool Pad** and place them on top of the **Ceramic Noodles** and **Carbon Bags**. Fig 3



10. Rinse the **Black Sponges** and place them on top of the **Wool Pads**. Fig 4

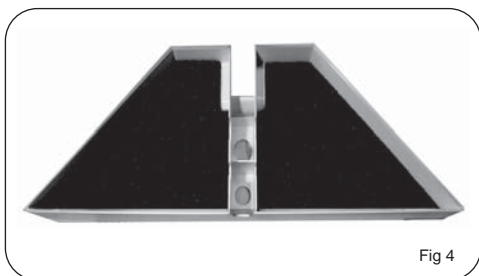

11. Connect the **Spray Bars** into the white **T** at the top of **Outlet**, the holes of the spray bar must point down.

12. Insert the complete **Spray Bar Unit** into the top of the **Power Head**, press down firmly ensure it is a tight fit. Fig 5

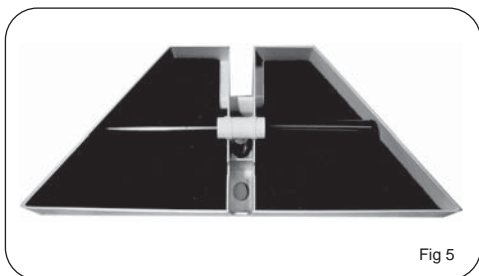

13. Connect the **Intake Pipe** and **Strainer** together. Fig 6



14. Insert them into the bottom of the **Power Head**. Fig 7



15. Place the aquarium on a flat level surface strong enough to support its weight. We recommend a genuine **Aqua One** Aquarium Cabinet (Sold separately) rather than general household furniture. Fig 8

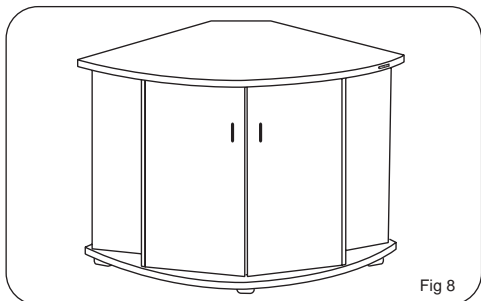

16. Place the **Filter Unit** (Once complete) on top of the **Aquarium Body** towards the back. Fig 9

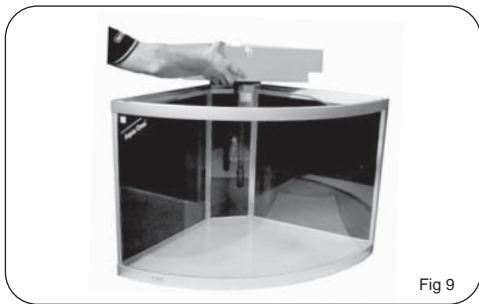

17. Wash aquarium gravel. Place a portion of gravel into a bucket, run water through & churn it over with your hand until the water running out of the bucket is clear. It is important to wash the gravel thoroughly. Repeat this process several times until all the gravel has been washed. Fig 10



18. Place washed gravel over the base of the Aquarium. Fig 11

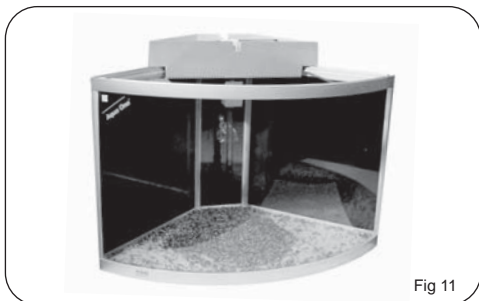

19. At this stage place plastic plants, decorations and heater (**See Tips**) into the tank. Fig 12



20. Fill the aquarium with tap water to the level indicated in Fig 13.

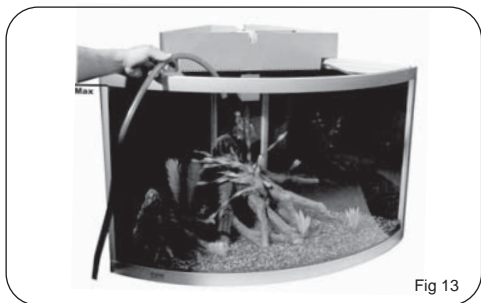

21. Use **Aqua One** quality Water Conditioner (Sold separately) to remove harmful chemicals from tap water. E.g. chlorine (**See Tips**) Fig 14

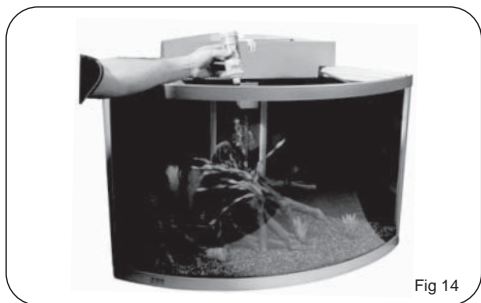

22. Place the **Light Unit** on the front of the Aquarium. Fig 15



23. Plug in the **Power Head, Light Unit and Heater** (If installed) and turn on. Fig 16. Refer to **Important Safeguards** for set up of the **Drip Loop**.



24. Insure the holes of the Spray Bar are facing down and that water is flowing through it.

25. Replace all lid on the **Filter Unit**.

26. Turn the light switch on ensure the lights work.

27. Test and adjust pH levels Fig 17

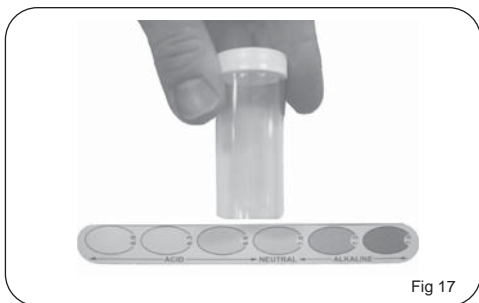

Introduction of Fish

28. Allow the aquarium to stand for 3 to 4 days before the introduction of any fish. Fig 18



Note: This is only a guide! You should seek professional advice from your aquarium specialist at the time of purchase.

DO NOT ADD ALL FISH AT ONCE!

Build stock levels slowly over time. Allow at least one week between additions of fish. Add a filter supplement to help the biological system cope with the additional waste.

Do not over crowd. Remember all fish will grow, so allow them adequate space.

29. Seek advice from your retailer for correct fish numbers and compatible species.

TIPS

Leave the carbon in the netting bag.

An Aqua One Heater and Thermometer is required if you are setting up a Tropical or Saltwater aquarium. Refer to heater instructions for correct set up and positioning.

Chlorine and other heavy metals will harm your fish. Aqua One Water Conditioner will remove these impurities and create a safe environment for your fish.

Filter Maintenance

WEEKLY

1. Turn the **Power Head** off.
2. Remove the **Lid** from the **Filter Unit**.
3. Remove the **Outlet** from the top of the **Power Head**.
4. Remove the **Black Sponges** and **Wool Pads** from the **Filter Unit**.
5. Empty a small amount of water from the aquarium into a bucket.
6. Rinse the **Black Sponges** in the bucket. Discard the used water; do not add it back into the aquarium.
7. Rinse the **Wool Pads** out under the tap, rinse thoroughly.
8. Re-insert the **Wool Pads** and **Black Sponges**.
9. Then connect the **Outlet** back in to the top of the **Power Head**. Make sure the holes of the **Spray Bar** are pointing down onto the **Black Sponge** and that the end of the **Spray Bars** have their caps fitted.
10. Ensure the aquarium is full. Refer to Fig 13
11. Turn the **Power Head** back on and ensure that water is flowing out of the **Spray Bar**.
12. Replace the **Lid** on the **Filter Unit**.
13. Add a filter supplement.

MONTHLY See diagrams on next page...

1. Turn the power off. And unplug both power leads.
2. Remove the **Light Unit** and Place it somewhere safe away from water and where it will not be broken / damaged.
3. Remove **Filter Unit** from aquarium and take to sink and remove the **Lid**.
4. Disconnect **Spray Bar** and **T Junction** and clean with double ended pipe brush.
5. Slide the **Power Head** off the bottom of the **Filter Unit**. Fig 1
6. You will need a flat head screw driver. Fig 2
7. Holding the **Power Head** upside down Insert the screw driver into the larger slot of the **Power Head**. Fig 3
8. Carefully lever the screw driver downwards.
9. This will pop one side of the **Impeller Cap** off. Fig 4
10. Turn the **Power Head** around, repeat steps 7, 8 & 9.

11. Grasp the **Impeller Cap** and remove it from the **Motor**. Fig 5
12. Remove the **Impeller**. (If it does not come out when the **Impeller Cap** is removed)
13. Use a double ended pipe brush to clean **Impeller** and inside of **Impeller Well**. Fig 6
14. Also run a pipe brush through the **Outlet** at the top of the **Power Head**.
15. Clean the **Intake Pipe** and **Strainer** thoroughly.
16. Reconnect all parts and place **Filter Unit** back onto the aquarium.
17. Ensure the power lead is not wet and plug it back in.
18. Turn the power back on and check that water is flowing through the **Spray Bar**.
19. Replace the **Light Unit** and **Lid**.

YEARLY

The Ceramic Noodles are designed to be maintenance free, **NEVER RINSE THEM IN TAP WATER**.

See *Hints & Tips for Best Results* for more information.

Filter Maintenance Diagrams

Fig 1

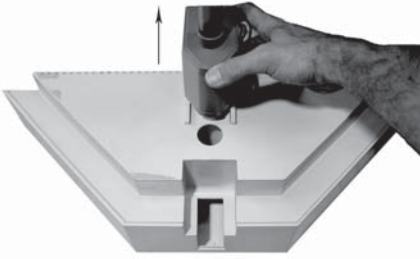

Fig 2



Fig 3

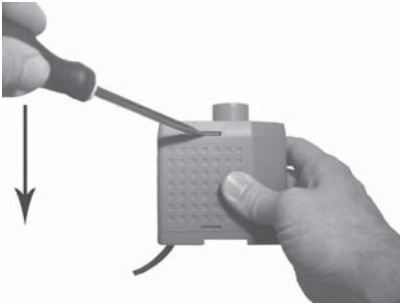

Fig 4

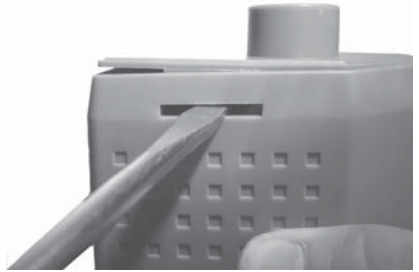

Fig 5

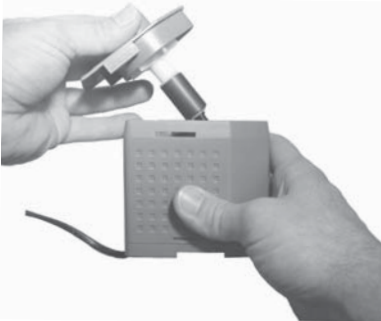
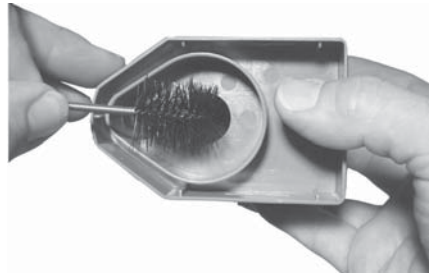

Fig 6



Hints & Tips For Best Results

LIVE PLANTS

Once the water conditions and pH levels have been corrected, live plants can be added to the aquarium. Remember to empty some water from the aquarium before adding anything to it.

REMEMBER LIVE PLANTS NEED TO BE FED! An aquarium safe plant fertiliser should be used.

LIGHTING

No more than 8 hours of light each day and definitely no natural light. Longer light times will accelerate algae growth in the aquarium and has no benefit to plants or fish.

- Specialist light tubes are available through retailers for saltwater and planted aquariums.

- We recommend replacing the light globe once every twelve months based on the light being on 8 hours a day as the spectrum of light changes over time and may cause excess algae growth.

FILTER MEDIA

Biological Filtration (Ceramic Noodles)

Biological filtration is a process where toxic nitrogen compounds such as ammonia and nitrite (Fish waste) are removed from the system via a breakdown process carried out by nitrifying bacteria. (Nitrobacter and Nitrosomonas). These nitrifying bacteria need substrate with a high surface area to adhere to such as **Ceramic Noodles**.

- When starting a new system it is important to remember that bacteria takes time to develop and grow.

- You can speed up the process by 'seeding' the system with commercially available bacterial cultures / filter supplements.

- Over time this media can block up or break down so it is important to monitor it. Seek

advice from your Aquarium Specialist if either of these problems arise.

Chemical Filtration (Carbon)

This is the removal of dissolved organic and inorganic substances through adsorption on a porous substrate or by direct chemical removal. Dissolved organic compounds are what turns the water a yellow-brown colour or causes foaming at the surface of the aquarium and should be removed.

- Remove carbon if treating fish with medication.
- Replace every 6 – 8 weeks as the carbons absorption capacity will have depleted.
- Rinse well before placing in the aquarium. (In tap water)

Mechanical/Biological Filtration (Filter Sponge/Wool Pad)

This is the process whereby suspended solids or particulate matter are removed from the water.

It is important to remove suspended solids not only to improve clarity of the water but also to:

- Avoid smothering the gills with solids such that fish cannot breathe.
- Decrease risk of disease outbreaks - there are high numbers of bacteria associated with suspended organic solids.
- Protect the biological filter material from rapidly becoming clogged.
- Can also act as a biological filter medium by providing sufficient surface area to host beneficial bacteria.

Trouble Shooting

If you are in any doubt about the electrical installation or safety of this product you must consult a qualified electrician.

LIGHT UNIT DOES NOT WORK

1. Ensure switch is in the on position on the top of the Light Unit.
2. Check light is plugged into power supply and the switch is on.
3. Check the globe is in good condition. Replace if needed.

POWER HEAD WORKING BUT NO / SLOW WATER FLOW

1. Check Impeller is in good condition and replace if needed.
2. Make sure water level in aquarium is above the Power Head. Please note the Power Head is a water proof unit.
3. Clean Impeller, Power Head and all Inlet and outlet pipes.
4. Check that the Spray Bar is inserted correctly with the end cap at the opposite end to the elbow.

AQUARIUM POSSIBLY LEAKING

1. Clean filter cartridge as this can create an overflow.
2. Make sure spray bar holes are pointed down onto the wool pads.
3. Make sure water level is not to high. Refer to Fig 13.
4. If an air stone is being used check it is not bubbling water over the rim of the aquarium if so turn the air pump down.
5. Make sure the aquarium is sitting on a level surface.
6. If it is a salt water aquarium remove any salt creep as it can drain water from the aquarium.

7a. Remove the Light Unit & Filter Unit from the top of the aquarium. Mark the water level. Remove any excess water that may be sitting on the edge of the aquarium. Leave for an hour. If water level drops proceed to step 7b.

7b. Remove the fish, decorations and gravel. Empty the aquarium and clean the glass **DO NOT WASH IN SOAP OR DETERGENT**. Place a piece of newspaper on a flat level solid surface. Carefully fill the aquarium ensuring not to spill any water on to the newspaper. Leave the aquarium for several hours and then inspect the newspaper for wet patches.

Aquarium Model: UFO 700
Dimensions: 70 x 71 x 70cm (10mm glass)
Aquarium Volume: 175L
Filter Flow Rate: 1000l/hr
Light Wattage: 3 x 23.5in 20W
Power Requirements: 220 ~ 240V
Suitable: Coldwater, Tropical, Marine

Aquarium Model: UFO 880
Dimensions: 88 x 76 x 88cm (10mm glass)
Aquarium Volume: 305L
Filter Flow Rate: 2000l/hr
Light Wattage: 2 x 36in 30W 1 x 23.5in 20W
Power Requirements: 220 ~ 240V
Suitable: Coldwater, Tropical, Marine

Precision Manufactured in the P.R.C.
Designed in Australia by Aqua One
Distributed in Australia by:
Kong's (Aust.) Pty. Limited
48 Williamson Rd. Ingleburn.
2565 NSW Australia.

Distributed in New Zealand by:
Kong's (NZ) Limited
52 Glenlyon Avenue. Greerton.
Tauranga New Zealand.

Distributed in Hong Kong by:
Kong's Aquarium Supplies Co., Ltd
No 31, 3/F Thriving Industrial Centre
26-38 Sha Tsui Road, Tsuen Wan,
Hong Kong.

Distributed in the UK by:
Kong's (UK) Limited,
C/O Aqua Pacific UK Ltd.
PO Box 268
Romsey Hampshire
SO51 0WW
United Kingdom.



Aqua One

www.aquaone.com.au

© Aqua One and Kong's are registered trademarks.