

**AquaStyle 510**

**Aqua One®**



**Instruction Manual**

# Important Safeguards

**This appliance is not intended for use by children or infirm persons without supervision. Young children should be supervised to ensure that they do not play with the appliance.**

**Warning: To guard against injury, basic safety precautions should be observed, including the following:**

1. Read and follow all safety instructions before using this appliance.

2. Danger: To avoid possible electric shocks, special care should be taken since water is employed in the use of aquarium equipment. For each of the following situations do not attempt repairs yourself. Return the appliance to an authorised service facility for service or discard the appliance.

a) If the light falls into water, do not reach for it, unplug it and then retrieve it. If the electrical components of the appliance get wet, unplug the appliance immediately (non immersible equipment only).

b) If the aquarium shows any sign of abnormal water leakage, immediately unplug it from the power source.

c) Carefully examine the aquarium after installation. It should not be plugged in when there is water on parts which are not intended to be wet.

d) Do not operate any aquarium electrical appliance if it has a damaged cord or plug, or if it is malfunctioning, or dropped or damaged in any manner.

e) If the external flexible cable or cord of this luminaire is damaged, it must be replaced by the manufacturer, it's service agent or similarly qualified persons in order to avoid a possible hazard.

f) The external flexible cable or cord of this power head cannot be replaced. If the cord is damaged the power head should be scrapped.

A "drip loop" (See the diagram) should be arranged by the user for each cord connecting an aquarium component to a receptacle. The drip loop is the part of the cord below the level of the receptacle or the connector if an extension cord is used. It is used to prevent water traveling along the cord and coming in contact with the receptacle.

If the plug or receptacle does get wet, do not unplug the appliance. Disconnect the fuse or circuit breaker that supplies the power to the appliance, then unplug and examine for presence of water in the receptacle.

3. Close supervision is necessary when the appliance is used by or near children.

4. Always unplug the aquarium from the electrical outlet, when not in use, before putting on or taking off parts, before any type of maintenance, or cleaning. Never yank the cord to pull it from the outlet. Grasp the plug and unplug to disconnect.

5. Do not use the aquarium for reasons other than the intended use. The use of attachments that are not recommended or sold by the aquarium manufacturer may cause the product to be unsafe. This is not recommended.

6. Do not install or store the aquarium where it will be exposed to weather or temperatures below freezing.

7. Make sure any component mounted on a tank is securely installed before operating it.

8. Read and observe all the important notices on the aquarium.

9. Ensure input voltage is the same voltage as your local power supply.

10. A G.F.C.I (Ground Fault Circuit Interrupter) & surge protector is recommended for all electrical appliances. (Light unit only)

11. Ensure your hand is dry when turning the power switch on/off and when inserting/removing the power cord from the receptacle.

12. If you are in any doubt about the electrical installation or safety of this product you must consult a qualified electrician.

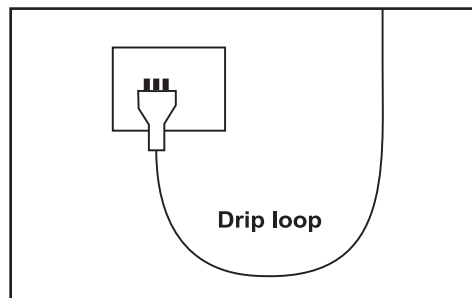

**For Guarantee Conditions, please refer to the Guarantee form that is enclosed with this product.**



**Warning:**

This appliance must not be disposed of together with domestic waste. It must be disposed of at an authorised centre set up for the recycling of electrical and electronic appliances. By collecting and recycling waste, you help save our natural resources. Please Make sure this product is disposed of in an environmental friendly and safe way.

## Before First Use / Preparation

Read and follow all the instructions, even if you feel you are familiar with the product and find a place to keep the instructions handy for future reference. Your attention is drawn particularly to the sections concerning “**IMPORTANT SAFEGUARDS**” and the “**AQUA ONE GUARANTEE**”. Please ensure you retain your original purchase receipt in the event that guarantee service is required.

Carefully unpack the aquarium making sure you keep all the packing material until all the parts of the product have been found and the product has been assembled.

## Know Your Tank



**Black Sponge**



**Ceramic Noodles**

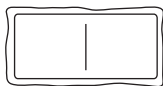

**2 x Carbon Cartridge**



**2 x Filter Grid**

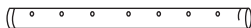

**Spray Bar**



**Intake Pipe**

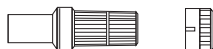

**Strainer**



**Elbow Adaptor**

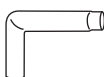

**Elbow**

This product is shipped to you in a factory sealed carton. Should the product malfunction in any way or if the unit is damaged and requires replacement, contact the retailer where the product was purchased for inspection.

The plug supplied with this product is a sealed plug and we do not recommend removing or changing it.

If the external flexible cable or cord of this luminaire is damaged, it must be replaced by the manufacturer, its service agent or similarly qualified persons in order to avoid a possible hazard.

The external flexible cable or cord of this power head cannot be replaced. If the cord is damaged the power head should be scrapped.

### Replacement Parts & Filter Media

Use Aqua One Genuine Spare Parts Only. See your local Aqua One Dealer and look for the number listed below for the spare part you require. Alternatively you will find these numbers on the silver label located on the product.

510 Black Sponge	2S
510 White Wool Pad	2W
510 Carbon Cartridge	2C
510 Impeller	2I

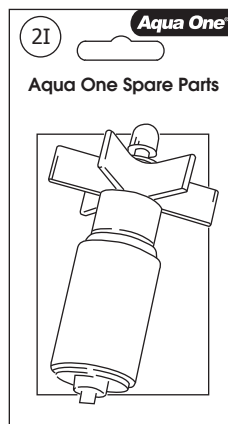

# Set Up Instructions

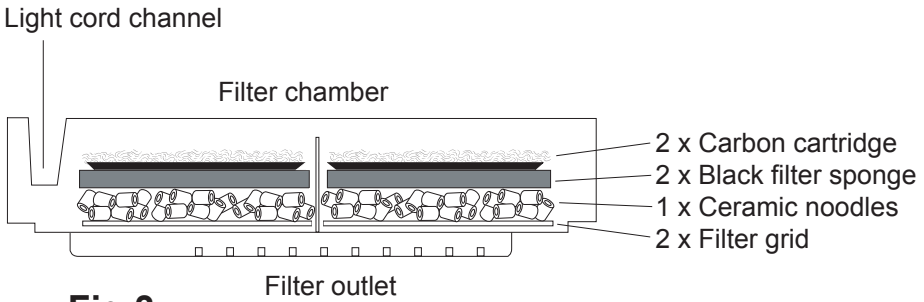
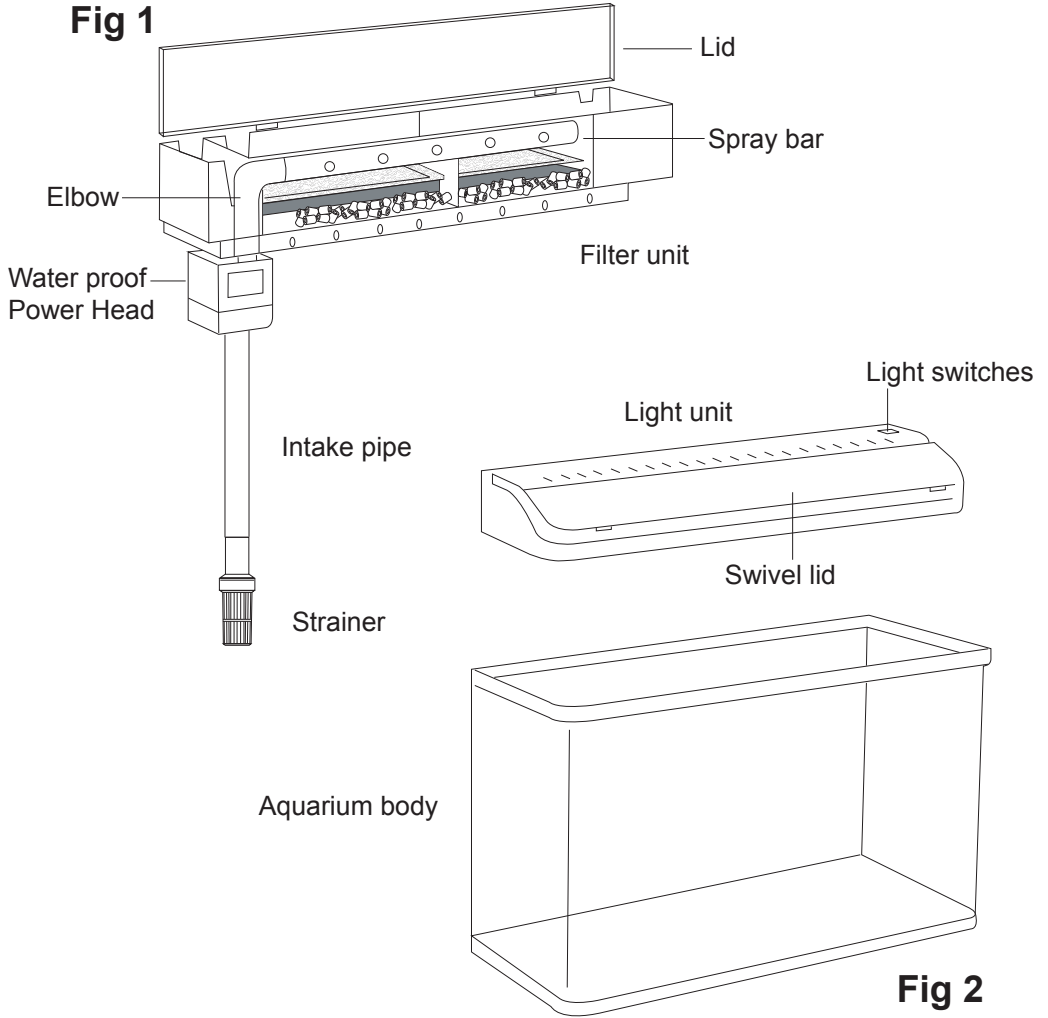

**Fig 3**

# Aquarium Set Up Instructions

1. Remove filter and light unit from the aquarium body.

2. Wash your hands and arms. It is very important to remove dirt, moisturizer and other impurities. Do this whenever you work on the aquarium.

3. Wash the following **DO NOT WASH IN SOAP OR DETERGENT**.

Black filter sponges, ceramic noodles (remove noodles from plastic bag), carbon cartridges, filter grids, spray bar, intake pipe, strainer, elbow, filter unit, glass tank (Inside).

4. Connect the intake pipe and strainer together.

5. Connect them to the bottom of the power head which is connected to the base of the filter unit. Fig 1

6. Place the filter grids in the bottom of the filter unit followed by the ceramic noodles. Fig 3

7. Place the black filter sponges on top of the ceramic noodles. Fig 3

8. Place the carbon cartridges on top of the black filter sponges with the wool facing upwards. Fig 3

9. Connect the elbow in to the top of the power head. The longer section of the elbow attaches over the outlet of the power head. **NOTE:** This should be a tight fit. Fig 1

10. Then connect the spray bar to the other end of the elbow. Make sure the holes of the spray bar are pointing down onto the carbon cartridges and that the end of the spray bar has the cap fitted. Fig 1

11. Consider where you are going to place the aquarium. Keep it away from direct light or areas with large temperature fluctuations.

12. Place the aquarium on a flat level surface strong enough to support its weight. We recommend a genuine Aqua One Aquarium Cabinet (Sold separately) rather than general household furniture.

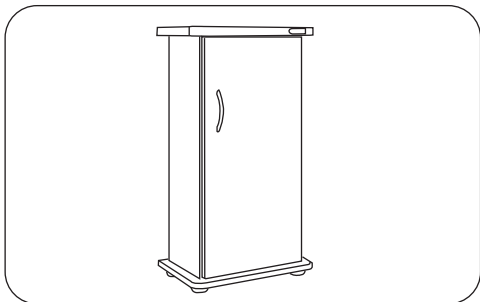

13. Wash aquarium gravel. Place a portion of gravel in a bucket, run water through and churn it over with your hand until the water is running clear. It is important to wash the gravel thoroughly. Repeat this process several times until all the gravel has been washed.

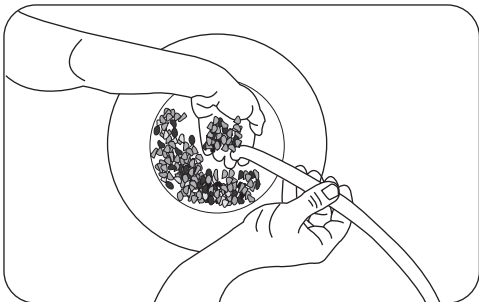

14. Place washed gravel over the base of the aquarium.

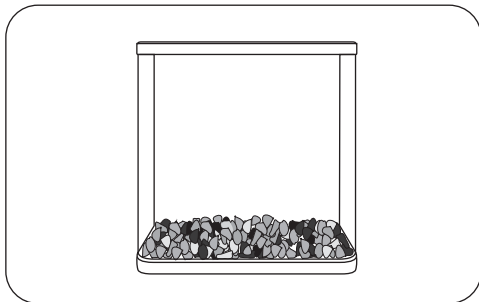

15. At this stage place plastic plants, decorations and heater if being used for tropical fish into the tank.

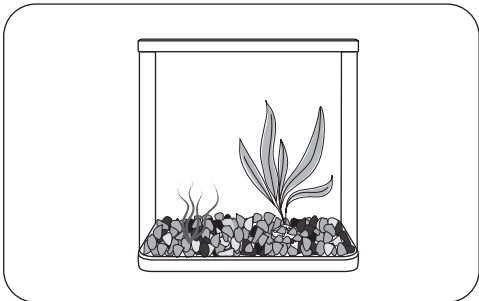

16. Fill the aquarium with tap water to the level indicated on the following page.

# Aquarium Set Up Instructions

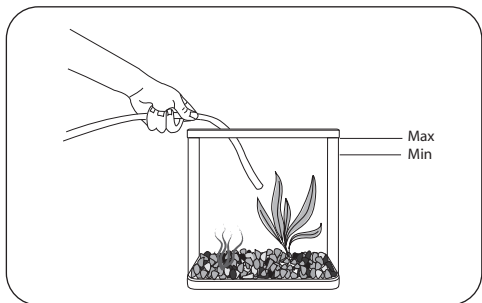

17. Use a good quality water conditioner (sold separately) to remove harmful chlorine and heavy metals from tap water.

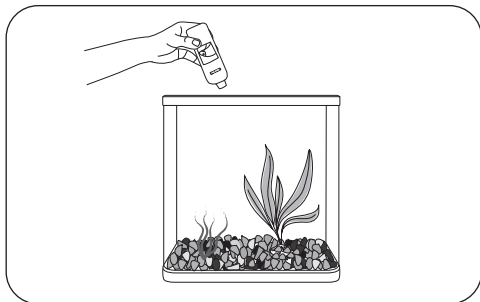

18. Place the filter unit (Once complete) on top of the aquarium body towards the back.

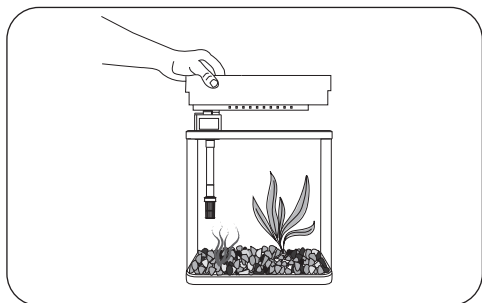

19. Place the light unit on the front of the aquarium, with the power cord passing through the light cord channel. Fig 3

20. Plug in the power head, light unit and heater (If installed) and turn on. Refer to Important Safeguards for set up of the Drip Loop.

21. Insure the holes of the spray bar are facing down and that water is flowing through it.

22. Close the lid on the filter unit.

23. Turn the light switches on, ensure the lights work.

24. Test and adjust pH levels.

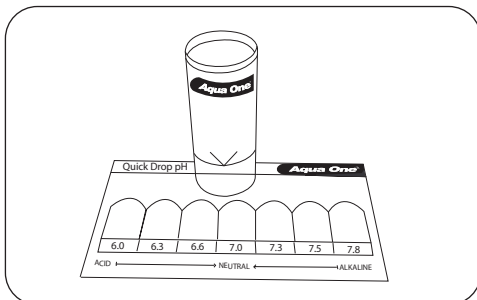

25. Allow the aquarium to stand for 5-7 days before introducing a few hardy fish.

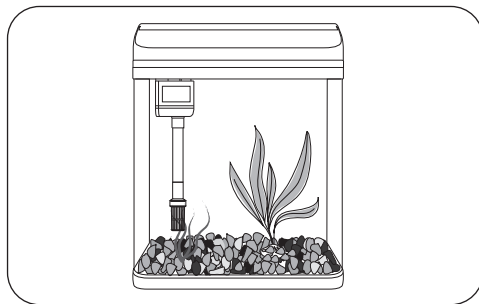

26. Seek advice from your retailer for correct fish numbers and species compatibility.

## TIPS

An Aqua One heater and Thermometer is required if you are setting up a tropical or saltwater aquarium. Refer to heater instructions for correct set up and positioning.

Chlorine and other heavy metals will harm your fish. Aqua One water conditioner will remove these impurities and create a safe environment for your fish.

These products are available separately from your local Aqua One retailer.

# Introduction of Fish

---

*Note: This is only a guide! You should seek professional advice from your aquarium specialist at the time of purchase.*

## **DO NOT ADD ALL FISH AT ONCE!**

Build stock levels slowly over time. Allow at least one week between additions of fish. Add a filter supplement to help the biological system cope with the additional waste.

Do not over crowd. Remember all fish will grow, so allow them adequate space.

## Tank Maintenance

---

**DAILY** Feed your fish as per instructions on your fish food container.

Check fish ensure they are eating, breathing and swimming normally.

Check temperature.

Count fish numbers.

Ensure all filters, pumps, heaters and other aquarium accessories are functioning correctly.

## **WEEKLY** *Test and adjust pH levels if needed*

Use Aqua One quality pH test kit, available from your local Aqua One retailer. pH is a measure of how acidic or alkaline the water is. It is measured on a scale of 0-14 in which 7 is neutral, less than 7 is acidic and more than 7 is alkaline.

Some species require specific pH levels please seek advice from your aquarium specialist.

## **FORTNIGHTLY** *25% Water Change*

What you will need: A bucket, gravel cleaner, towel, water conditioner, filter supplement and clean hands. All items are available from your local Aqua One retailer.

1. Unplug the light unit and remove it from the aquarium. Place it somewhere safe away from water & where it will not be broken / damaged.

2. Turn the power head off.

3. The fish and plants do not need to be removed when doing any maintenance.

4. Place the towel on the floor in front of the aquarium to guard from water spillage.

5. Use an Aqua One 4 in 1 algae scraper (Sold separately) and gently scrape away any algae growing on the glass or filter pipes.

6. Using an Aqua One gravel cleaner\* (Sold separately) empty approximately 25% of the aquarium water into the bucket. Take note of how much water is emptied.

7. Fill the bucket up with the same amount of water that was removed from the aquarium.

8. Treat the tap water with Aqua One water conditioner (Sold separately) as per the instructions on the bottle.

9. Let the bucket sit for 10 minutes.

10. Fill the aquarium up slowly to the level indicated on page 6

11. Turn the power head back on and ensure that water is flowing out of the spray bar.

12. Test and adjust pH levels.

13. Add a filter supplement .

12. Replace the light unit.

**\* Refer to the instructions on the back of your gravel cleaner to ensure correct use.**

# Filter Maintenance

## WEEKLY

1. Turn the power head off.
2. Open the lid of the filter unit.
3. Remove the elbow and spray bar unit from the top of the power head.
4. Remove the carbon cartridges and black sponges from the filter unit.
5. Empty a small amount of water from the aquarium into a bucket.
6. Rinse the black filter sponges in the bucket. Discard the used water; do not add it back into the aquarium.
7. Rinse the carbon cartridges out under the tap, rinse thoroughly.
8. Re-insert the black filter sponges and carbon cartridges.
9. Then connect the elbow and spray bar unit back onto the outlet at the top of the power head. Make sure the holes of the spray bar are pointing down onto the carbon cartridge and that the end of the spray bar has the cap fitted.
10. Ensure the aquarium is full. Refer to page 6
11. Turn the power head back on and ensure that water is flowing out of the spray bar.
12. Close the lid on the filter unit.
13. Add a filter supplement.

The carbon filter cartridges should be replaced every 6 - 8 weeks for optimum filter performance.

## MONTHLY See diagrams on next page...

1. Turn the power off. Unplug both power leads.
2. Remove the light unit and place it somewhere safe away from water and where it will not be broken / damaged.
3. Remove filter unit from aquarium, take to sink and open the lid.
4. Disconnect spray bar and elbow and clean with double ended pipe brush.
5. Slide the power head to the left to remove from filter unit.
6. Pull impeller cap off bottom of power head, this will uncover the impeller.

7. Hold the power head with both hands. With your right hand press in and hold the tabs on the impeller cap marked with the following symbol:



Then pull the impeller cap away from the power head.

8. Grasp the impeller blades and remove from the impeller chamber.
9. Use an Aqua One double ended pipe brush to clean impeller and inside of impeller chamber.
10. Also run a pipe brush through the outlet at the top of the power head.
11. Clean the intake pipe and strainer thoroughly.
12. Reconnect all parts and place filter unit back onto the aquarium.
13. Ensure the power lead is not wet and plug it back in.
14. Turn the power back on and check that water is flowing though the spray bar.
15. Replace the light unit.

## YEARLY

The Ceramic Noodles are designed to be maintenance free, NEVER RINSE THEM IN TAP WATER!

See Hints & Tips for Best Results for more information.

## Notes

---

---

---

---

---

---

---

---

---

---

---



# Filter Maintenance

## Filter Maintenance Diagrams

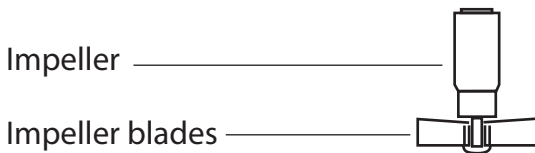
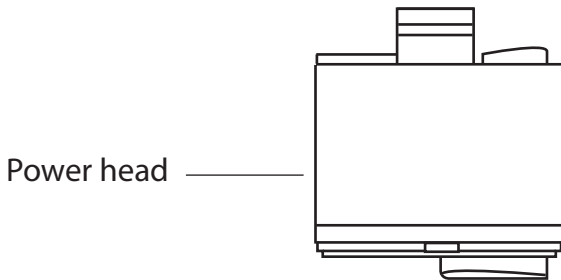
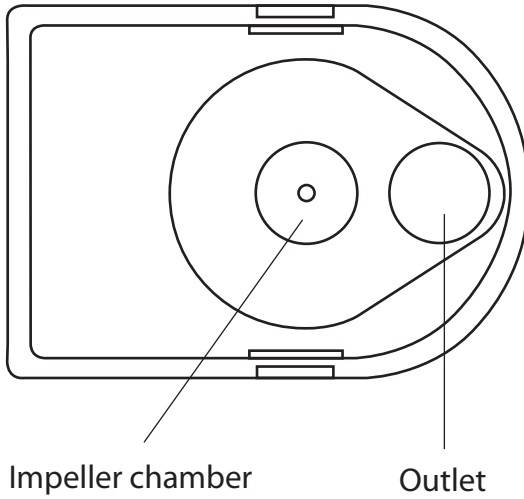

# Hints & Tips For Best Results

---

## LIVE PLANTS

Once the water conditions and pH levels have been corrected, live plants can be added to the aquarium. Remember to empty some water from the aquarium before adding anything to it.

**REMEMBER LIVE PLANTS NEED TO BE FED!** An aquarium safe plant fertiliser should be used.

## LIGHTING

No more than 8 hours of light each day and definitely no natural light. Longer light times will accelerate algae growth in the aquarium and has no benefit to plants or fish.

- Specialist light tubes are available through retailers for saltwater and planted aquariums.
- We recommend replacing the light globe once every twelve months based on the light being on 8 hours a day as the spectrum of light changes over time and may cause excess algae growth.

## FILTER MEDIA

### Biological Filtration (Ceramic Noodles)

Biological filtration is a process where toxic nitrogen compounds such as ammonia and nitrite (Fish waste) are removed from the system via a breakdown process carried out by nitrifying bacteria. (Nitrobacter and Nitrosomonas). These nitrifying bacteria need substrate with a high surface area to adhere to such as **Ceramic Noodles**.

- When starting a new system it is important to remember that bacteria takes time to develop and grow.
- You can speed up the process by 'seeding' the system with commercially available bacterial cultures / filter supplements.
- Over time this media can block up or break down so it is important to monitor it.

Seek advice from your Aquarium Specialist if either of these problems arise.

### Mechanical/Chemical Filtration (Carbon Cartridges)

This is the removal of dissolved organic and inorganic substances through adsorption on a porous substrate or by direct chemical removal. Dissolved organic compounds are what turns the water a yellow-brown colour or causes foaming at the surface of the aquarium and need to be removed.

- Remove carbon cartridges if treating fish with medication.
- Replace every 6 – 8 weeks as the carbon's absorption capacity will have depleted.
- Rinse well before placing in the aquarium. (in tap water)

### Mechanical/Biological Filtration (Filter Sponges)

This is the process whereby suspended solids or particulate matter are removed from the water.

It is important to remove suspended solids not only to improve clarity of the water but also to:

- Avoid smothering the gills with solids such that fish cannot breathe.
- Decrease risk of disease outbreaks - there are high numbers of bacteria associated with suspended organic solids.
- Protect the biological filter material from rapidly becoming clogged.
- Can also act as a biological filter medium by providing sufficient surface area to host beneficial bacteria.

# Trouble Shooting

If you are in any doubt about the electrical installation or safety of this product you must consult a qualified electrician.

## LIGHT UNIT DOES NOT WORK

1. Ensure switch is in the on position on the top of the light unit.
2. Check light is plugged into power supply and the switch is on.
3. Check the globes are in good condition. Replace if needed.

## POWER HEAD WORKING BUT NO / SLOW WATER FLOW

1. Check impeller is in good condition and replace if needed.
2. Make sure water level in aquarium is above the power head. Please note the power head is a water proof unit.
3. Clean impeller, power head and all inlet and outlet pipes.
4. Check that the spray bar is inserted correctly with the end cap at the opposite end to the elbow.

## AQUARIUM POSSIBLY LEAKING

1. Clean carbon cartridges as this can create an overflow.
  2. Make sure spray bar holes are pointed down onto the carbon cartridges.
  3. Make sure water level is not too high Refer to page 6.
  4. If an air stone is being used check it is not bubbling water over the rim of the aquarium if so turn the air pump down.
  5. Make sure the aquarium is sitting on a level surface.
  6. If it is a salt water aquarium remove any salt creep as it can drain water from the aquarium.
- 7a. Remove the light unit & filter unit from the top of the aquarium. Mark the water level. Remove any excess water that may be sitting on the edge of the aquarium. Leave for an hour. If water level drops proceed to step 7b.

7b. Remove the fish, decorations and gravel. Empty the aquarium and clean the glass **DO NOT WASH IN SOAP OR DETERGENT**. Place a piece of newspaper on a flat level solid surface. Carefully fill the aquarium ensuring not to spill any water on to the newspaper. Leave the aquarium for several hours and then inspect the newspaper for wet patches.

**Aquarium Model:** AquaStyle 510  
**Dimensions:** 51 x 54 x 34cm (5mm glass)  
**Aquarium Volume:** 75L  
**Filter Flow Rate:** 750l/hr  
**Light Wattage:** 2 x 11W  
**Power Requirements:** 220 ~ 240V  
**Suitable:** Coldwater, Tropical, Marine

Precision Manufactured in the P.R.C.  
Designed in Australia by Aqua One  
Distributed in Australia by:  
**Kong's (Aust.) Pty. Limited**  
48 Williamson Rd. Ingleburn  
2565 NSW Australia

Distributed in New Zealand by:  
**Kong's (NZ) Limited**  
52 Glenlyon Avenue. Greerton  
Tauranga New Zealand

Distributed in Hong Kong by:  
**Kong's Aquarium Supplies Co., Ltd**  
No 31, 3/F Thriving Industrial Centre  
26-38 Sha Tsui Road, Tsuen Wan  
Hong Kong

Distributed in the UK by:  
**Kong's (UK) Limited,**  
C/O Aqua Pacific UK Ltd.  
PO Box 268  
Romsey Hampshire  
SO51 0WW  
United Kingdom



**Aqua One**

**www.aquaone.com.au**

Aqua One and Kong's are registered trademarks.



220 - 240V ~ 50HZ



Keep an eye out for these Aqua One products at your local retailer...



**Fish keeping has never been easier...**

Aqua One specialises in all of your aquarium needs.

Aqua One uses state of the art technology which results in the most efficient and superior aquarium products.

The Aqua One range includes a wide range of curved glass aquariums, air pumps, filters, power heads, heaters, reflectors, under water lighting, along with fish foods, cleaning and maintenance accessories and decorations.

**[www.aquaone.com.au](http://www.aquaone.com.au)**