

Cabinet Assembly Instructions

Aqua One[®]

AquaMode 600



Contents:



Ax6



Bx6



Cx6



Dx5



Ex1



Fx8



Gx5

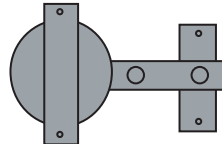

Hx2



Ix4

Tools required:

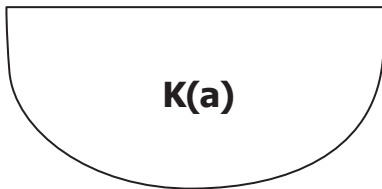

Top
(View
from
above)

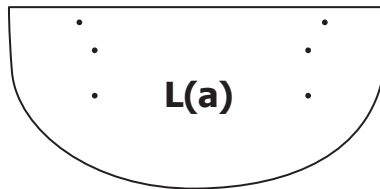

Base
(View
from
above)

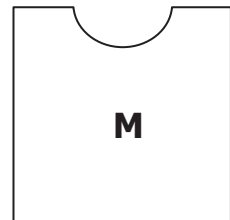

Shelf

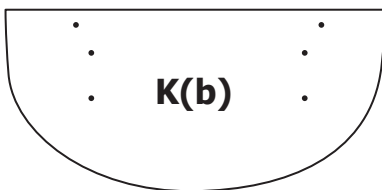

Top
(View
from
below)

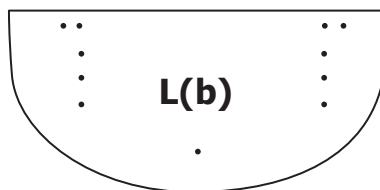

Base
(View
from
below)

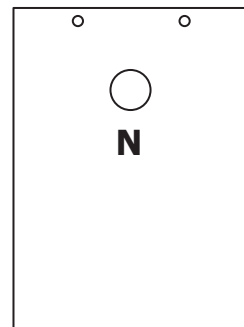

Back
panel

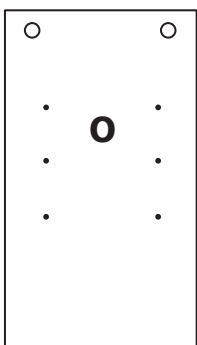

Side
(left)

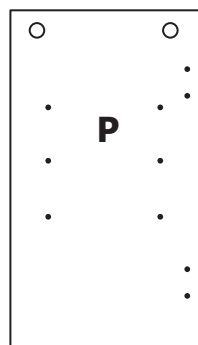

Side
(right)

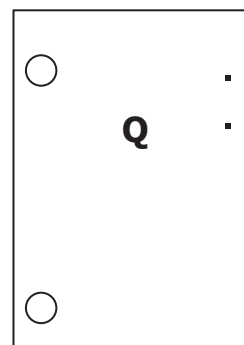

Door

Step 1: Use panels K(b), N, O, P. Use parts A x 6, B x 6. Install the screws A x 6 to panel K(b) and locking nuts B x 6 to panels N, O, P, then attach the back panel N to K (b) and lock.

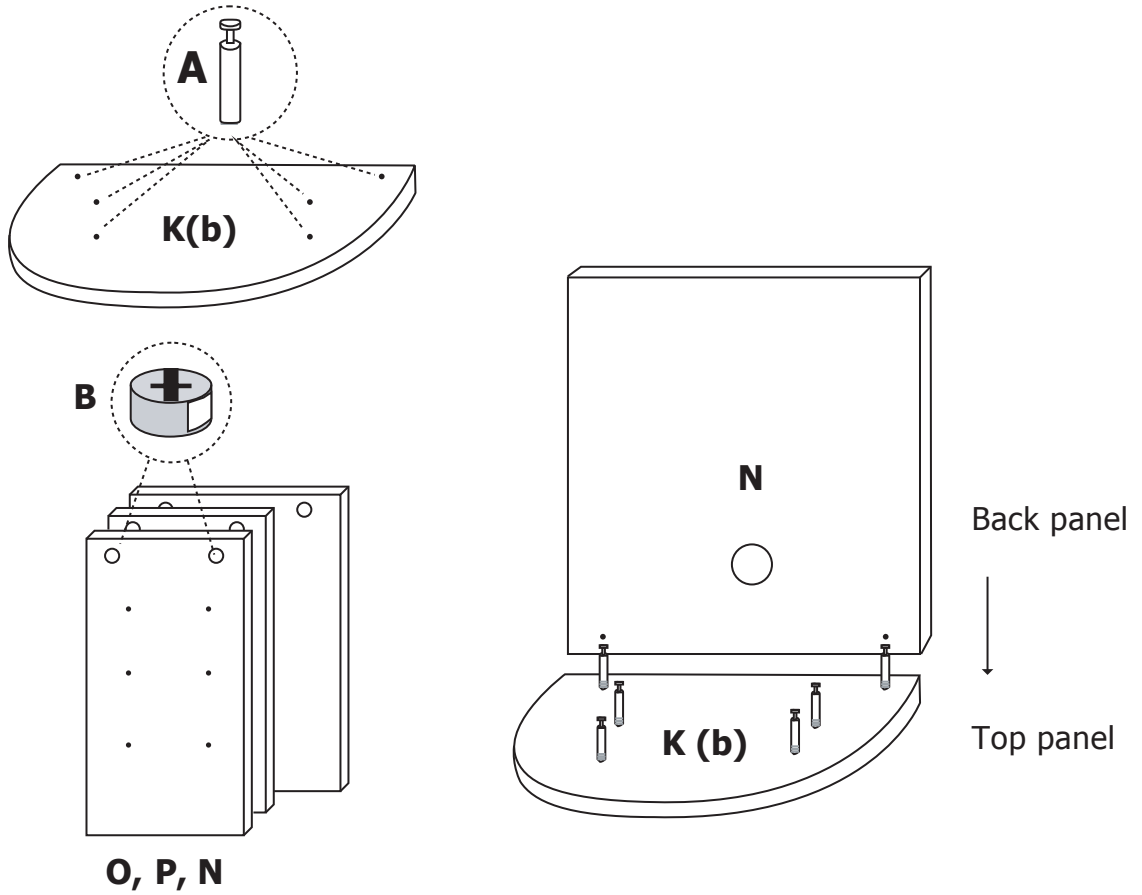

Step 2: Install Panels O, P to K (b) and lock.

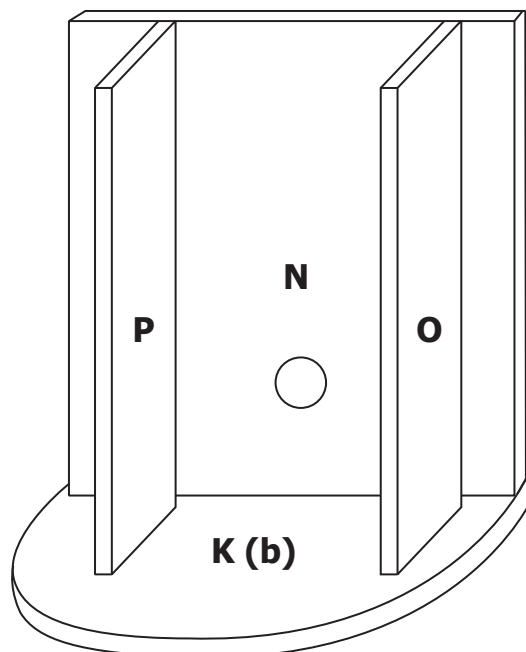

**Step 3: Install the base. Use panel L(b).
Use parts C x 6, G x 5, D x 5.**

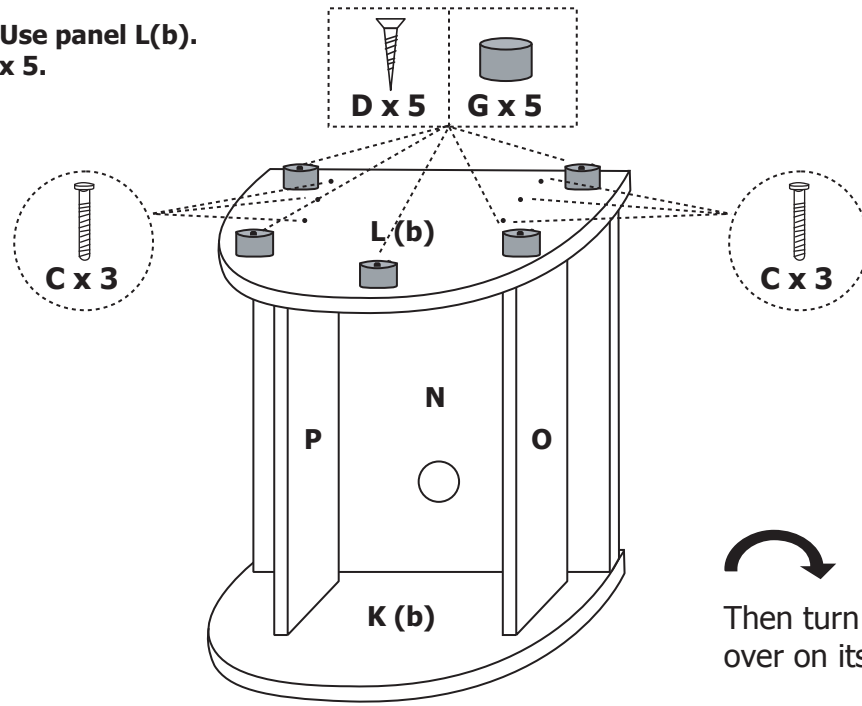

Step 4: Install the shelf. Use panel M. Use parts I x 4.

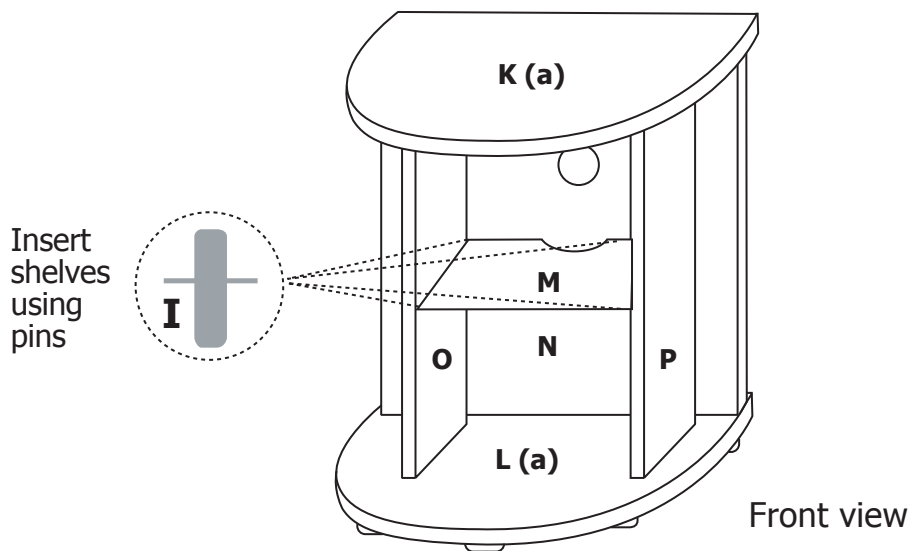

**Step 5: Fasten hinges to the door panel using screws (F). Attach the door handle.
Use panel Q. Use parts H x 2, F x 4, E x 1.**

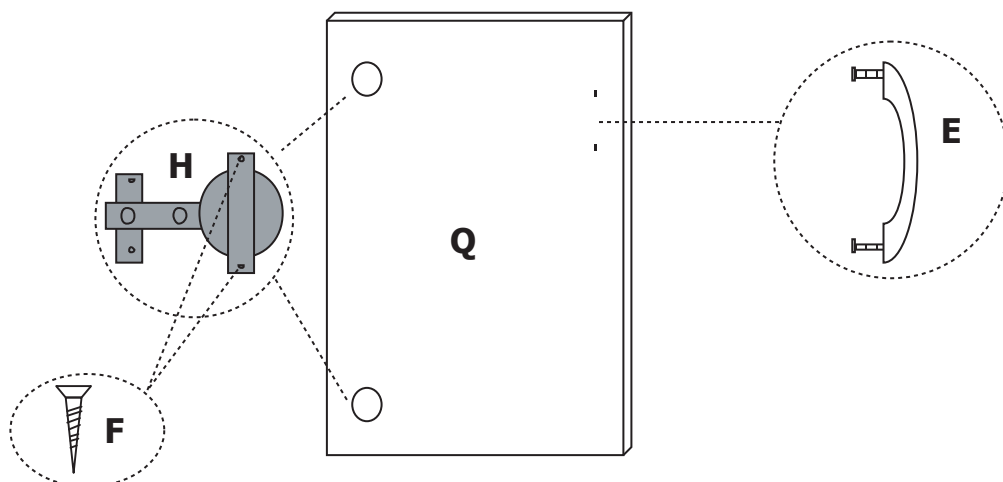

**Step 6: Attach door Q to cabinet using screws F into the predrilled holes.
Use parts F x 4.**

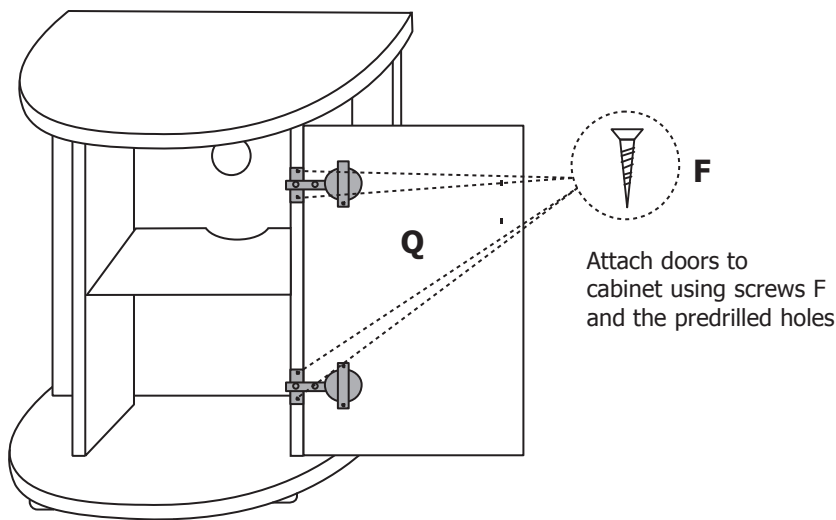

Your cabinet is now complete.

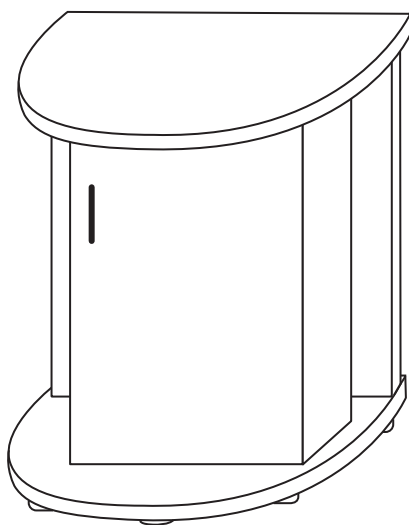

Important Notice

It is absolutely imperative that you ensure this cabinet and aquarium is installed upon level flooring. It is also a prerequisite that you ensure the flooring upon which it is positioned is able to support the weight of this aquarium which could be up to **600kg** including water and decorations.

Installation upon uneven flooring will result in poor distribution of weight. Damages to the aquarium, cabinet or equipment and damages caused by leaks due to improper or uneven installation are not covered by the guarantee with this product.

Care and Maintenance of your Aqua One Aquarium

Glass: It is recommended that you use a good quality glass cleaner and a non abrasive lint free cloth. Glass cleaner should only be used on the outside of the aquarium.

To clean the glass on the inside of the aquarium, it is recommended that you use an Aqua One Scraper or Magnetic Cleaner (available from your local Aqua One dealer).

Cabinet and Hood: The use of a damp cloth is recommended, do not use any detergents or harsh chemicals to clean the cabinet and hood as damage may occur.

Precision Manufactured in the P.R.C.
Designed in Australia by Aqua One
Distributed in Australia by:
Kong's (Aust.) Pty. Limited
48 Williamson Rd. Ingleburn.
2565 NSW Australia.

Distributed in New Zealand by:
Kong's (NZ) Limited
52 Glenlyon Avenue.
Greerton. Tauranga New Zealand.

Distributed in the UK by:
Kong's (UK) Ltd.
C/O Aqua Pacific UK Ltd.
PO Box 268
Romsey Hampshire
S051 0WW
United Kingdom

® Aqua One and Kong's are registered trademarks. www.aquaone.com.au. © Aqua One 2005