

Cabinet Assembly Instructions

Aqua One

AquaStyle 850/980, AquaGrande 120



Tools required:



Contents:



Ax8



Bx8



Cx16



Dx6



Ex2



Fx16

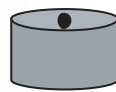

Gx6

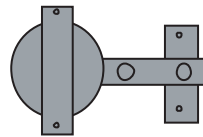

Hx4



Ix8



Jx2



Kx8

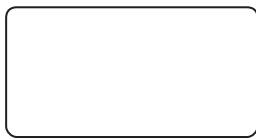

L(a)

Top
(View
from
above)

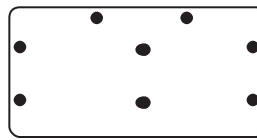

M(a)

Base
(View
from
above)

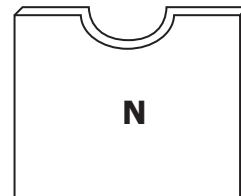

N

Shelves x 2

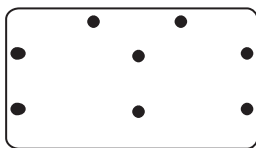

L(b)

Top
(View
from
below)

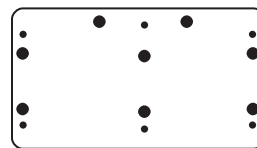

M(b)

Base
(View
from
below)

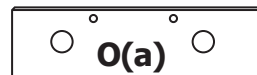

O(a)

Back panel

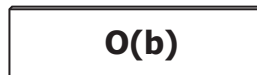

O(b)

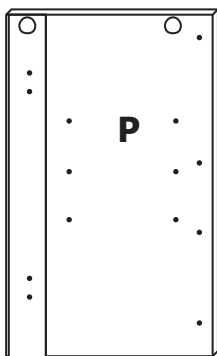

Left side

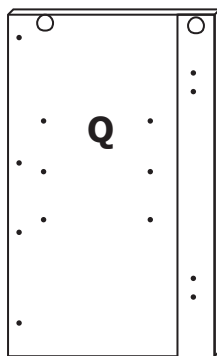

Right side

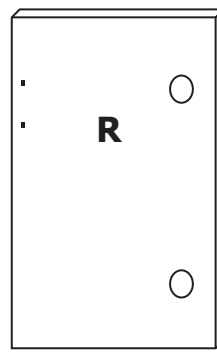

Left door

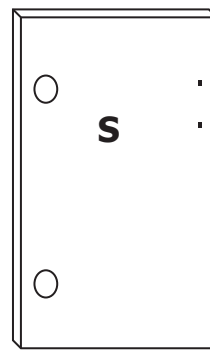

Right door

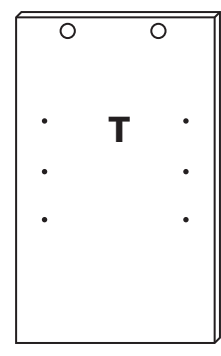

Centre Panel

Step 1: Install the locking nuts, screws and door hinges.
 Use panels L(b), O, P, Q, T, R, S. Use parts A x 8, B x 8, H x 4, F x 8, E x 2.

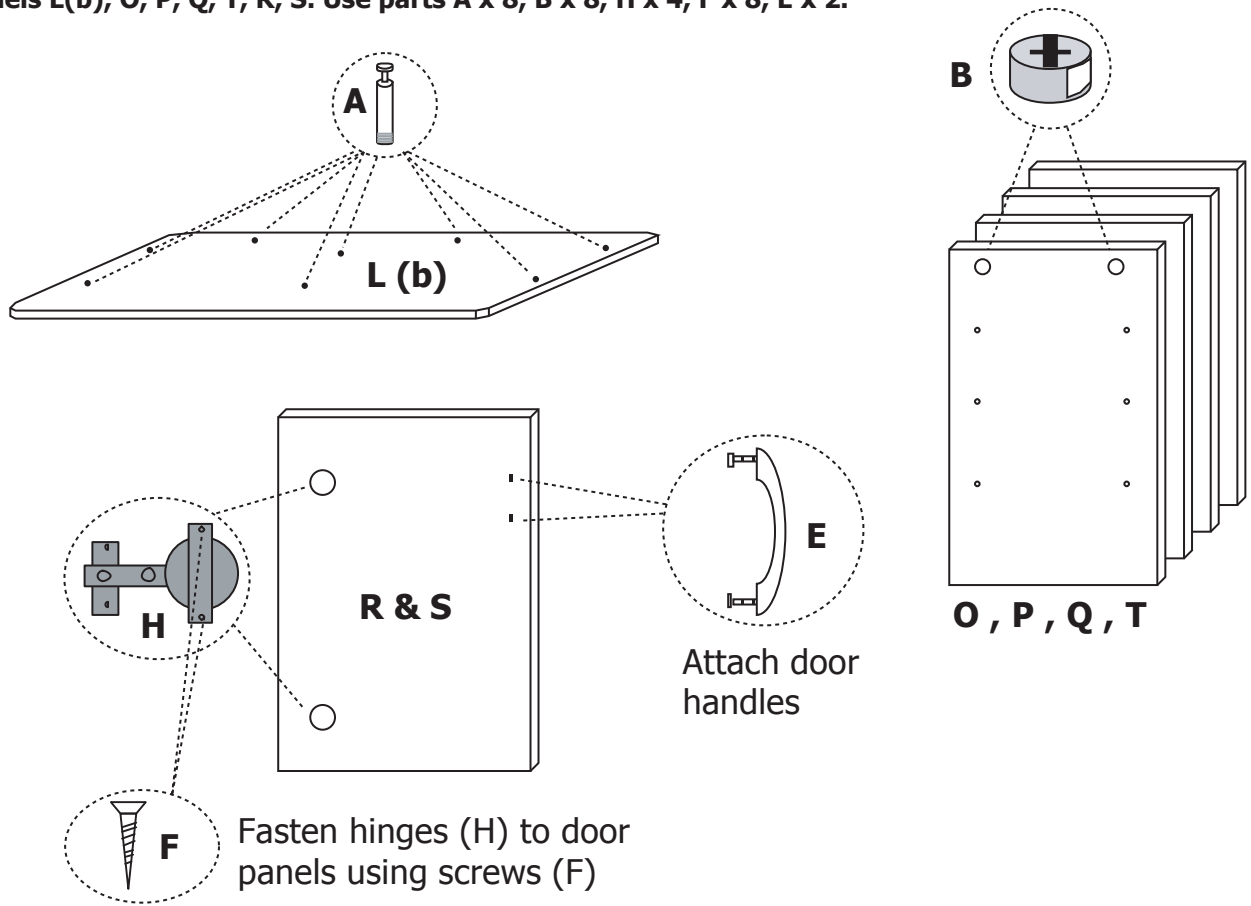

Step 2: Install the side, centre and back panels to the top.
 Use panels P, T, Q, O (b), O (a). Use parts C x 8, J x 2, B x 2.

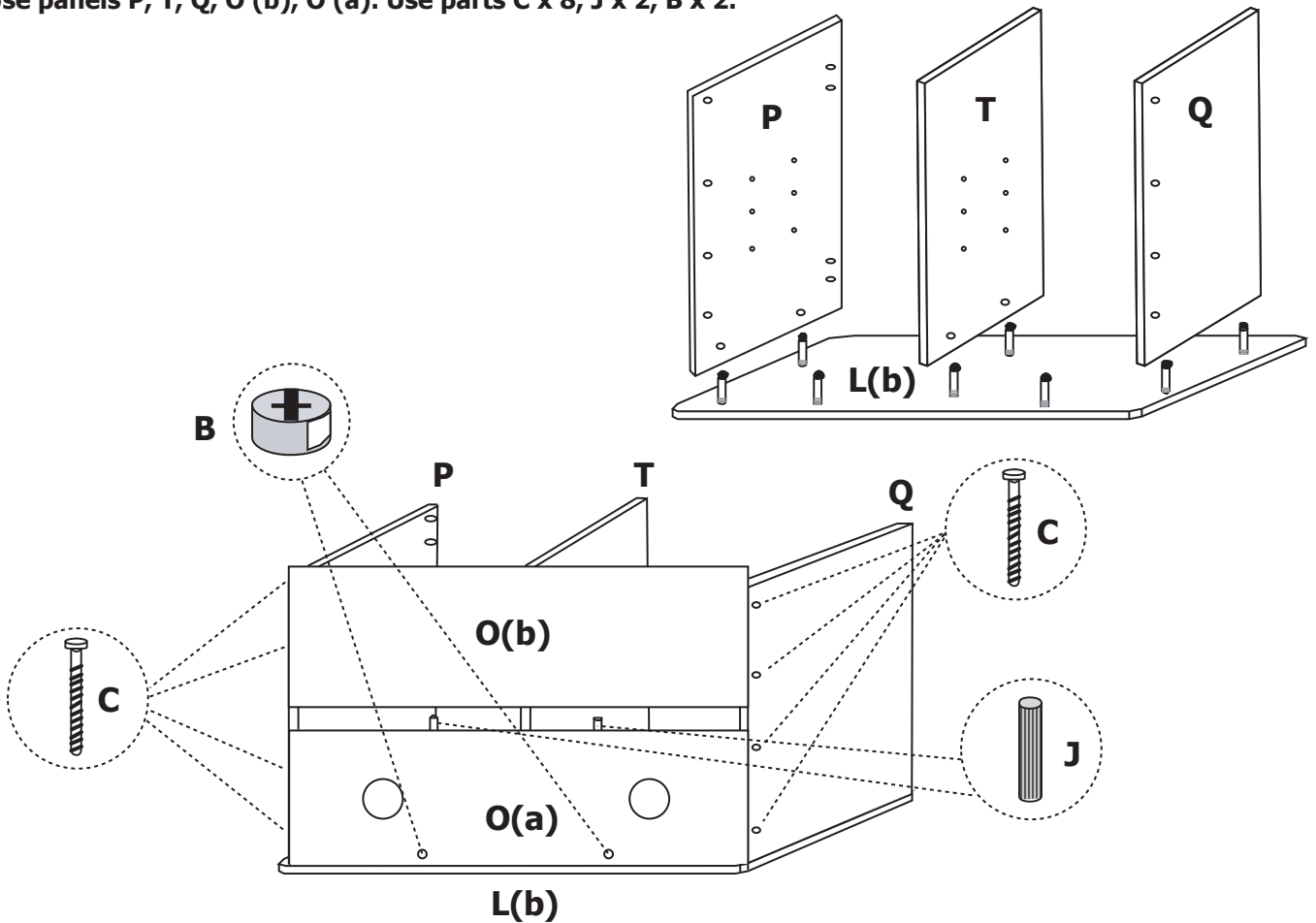

Step 3: Attach base and install feet.
Use panel M(b). Use parts C x 8, G x 6, D x 6.

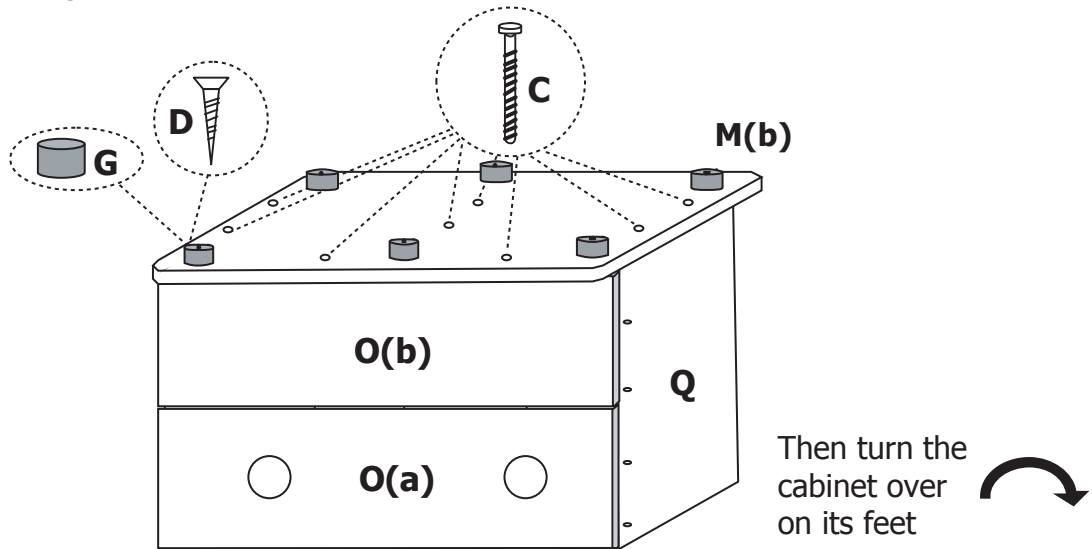

Step 4: Install the shelves and screw caps.
Use panels N x 2. Use parts I x 8, J x 8.

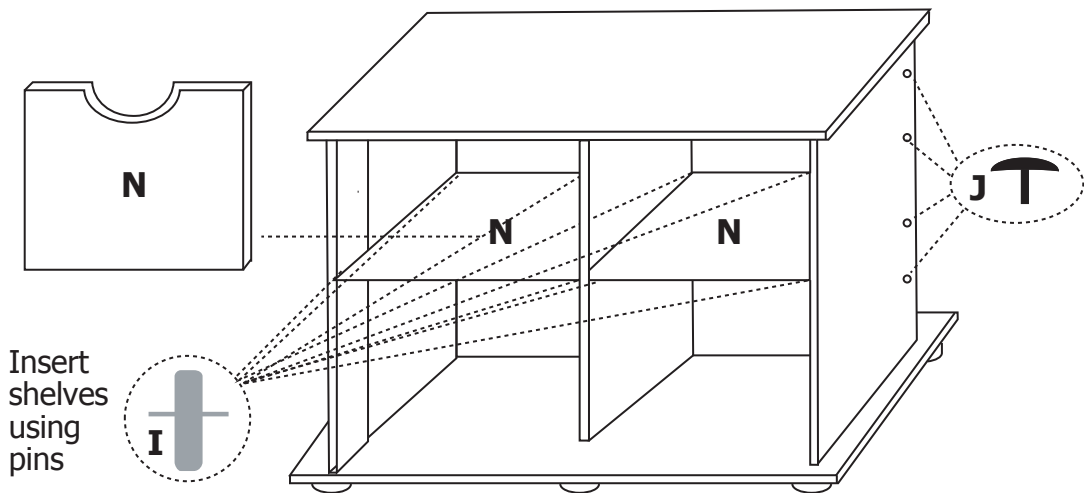

Step 5: Attach doors R & S to cabinet using screws F into the predrilled holes.
Use parts F x 8.

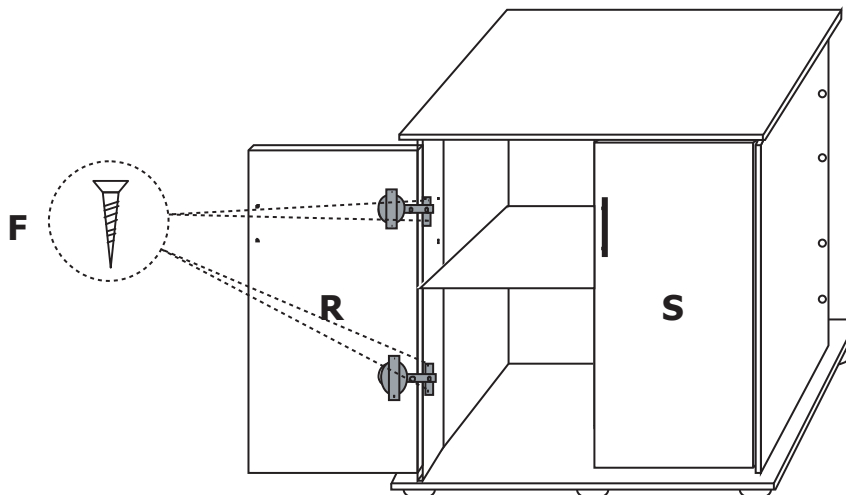

Your cabinet is now complete.

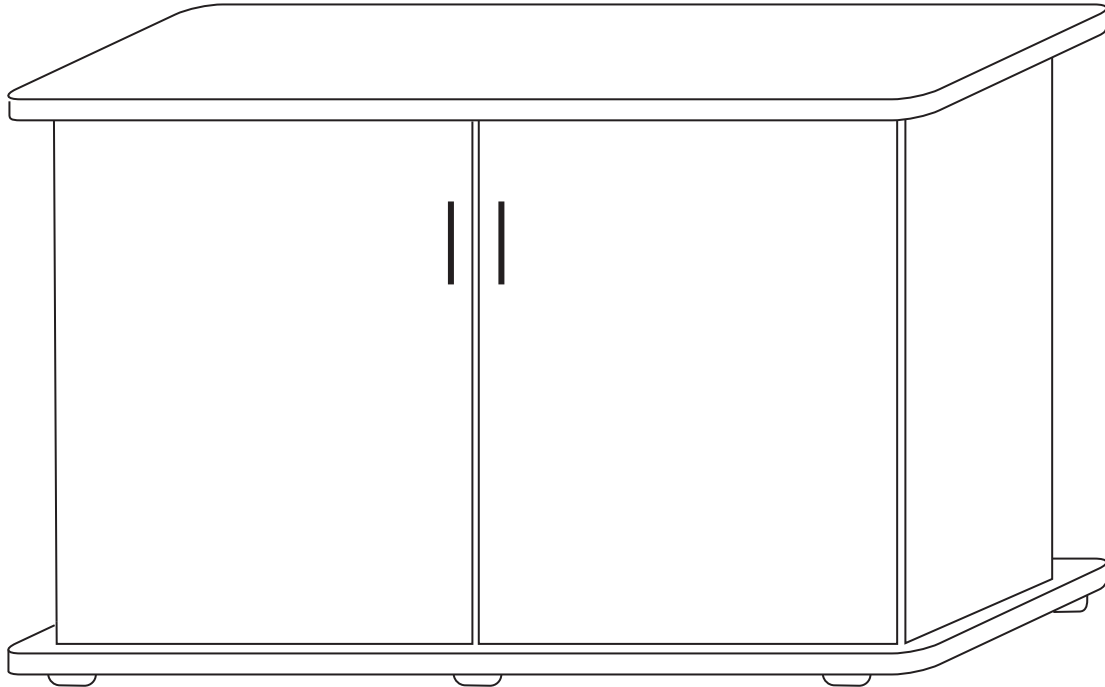

Important Notice

It is absolutely imperative that you ensure this cabinet and aquarium is installed upon level flooring. It is also a prerequisite that you ensure the flooring upon which it is positioned is able to support the weight of this aquarium which could be up to **600kg** including water and decorations.

Installation upon uneven flooring will result in poor distribution of weight. Damages to the aquarium, cabinet or equipment and damages caused by leaks due to improper or uneven installation are not covered by the guarantee with this product.

Care and Maintenance of your Aqua One Aquarium

Glass: It is recommended that you use a good quality glass cleaner and a non abrasive lint free cloth. Glass cleaner should only be used on the outside of the aquarium.

To clean the glass on the inside of the aquarium, it is recommended that you use an Aqua One Scraper or Magnetic Cleaner (available from your local Aqua One dealer).

Cabinet and Hood: The use of a damp cloth is recommended, do not use any detergents or harsh chemicals to clean the cabinet and hood as damage may occur.

Precision Manufactured in the P.R.C.
Designed in Australia by Aqua One
Distributed in Australia by:
Kong's (Aust.) Pty. Limited
48 Williamson Rd. Ingleburn.
2565 NSW Australia.

Distributed in New Zealand by:
Kong's (NZ) Limited
52 Glenlyon Avenue.
Greerton. Tauranga New Zealand.

Distributed in the UK by:
Kong's (UK) Ltd.
C/O Aqua Pacific UK Ltd.
PO Box 268
Romsey Hampshire
S051 0WW
United Kingdom